

# 980423

1.

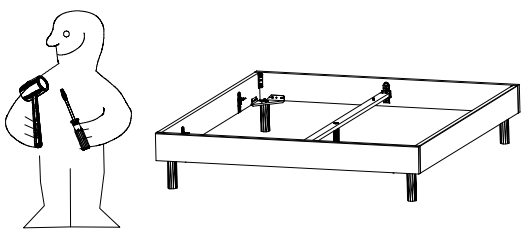

2.

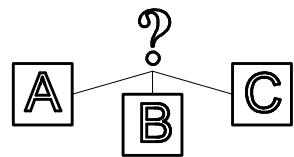
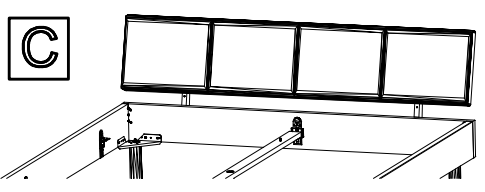
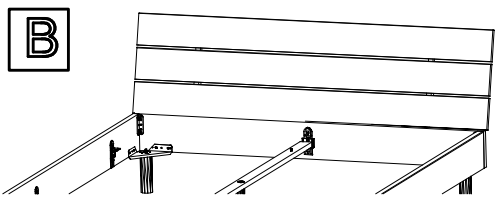
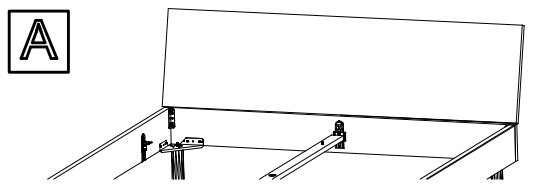
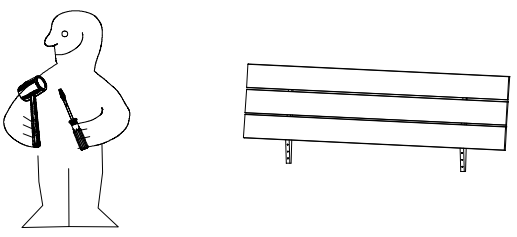

**A**

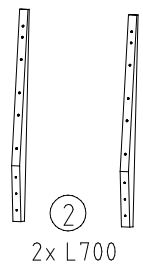
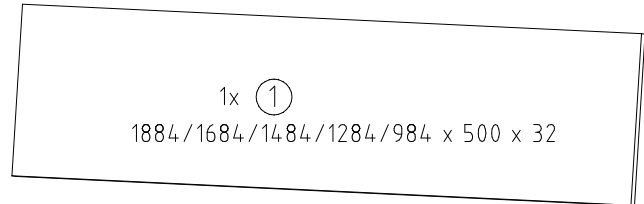

**B**

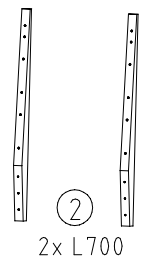
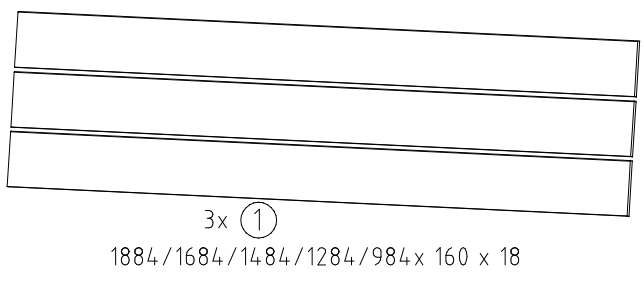

**C**

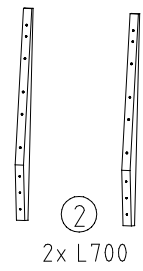
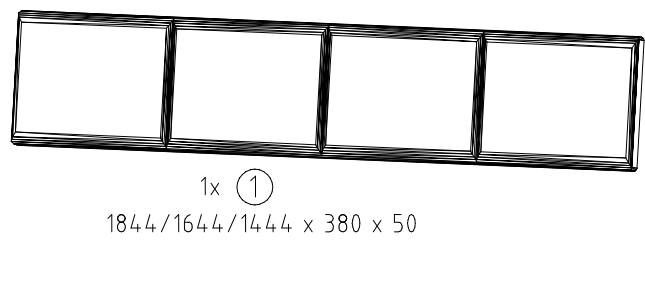

o16	<b>A</b>	<b>B</b>
	2x	
111 004 4,0 x 15 mm	<b>A</b>	<b>B</b>
G23	8x	
121 110		
121 115	SP40	
	6x	
4 X 40 mm		
4 X 27mm	<b>A</b>	<b>B</b>
SP27	6x	12x10x
122620		

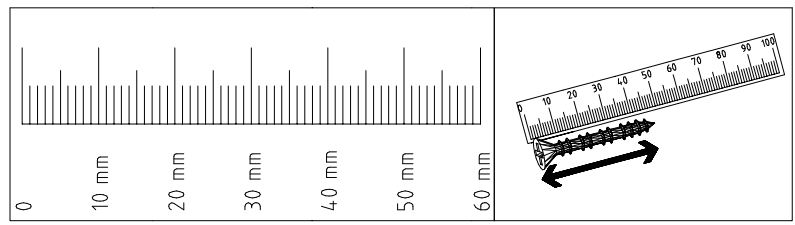
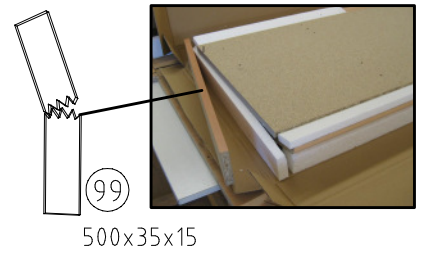
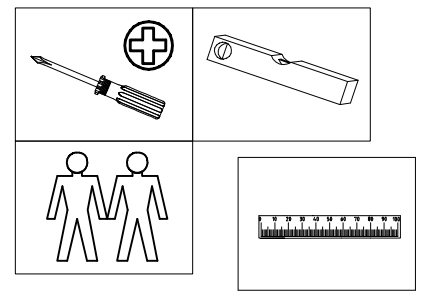

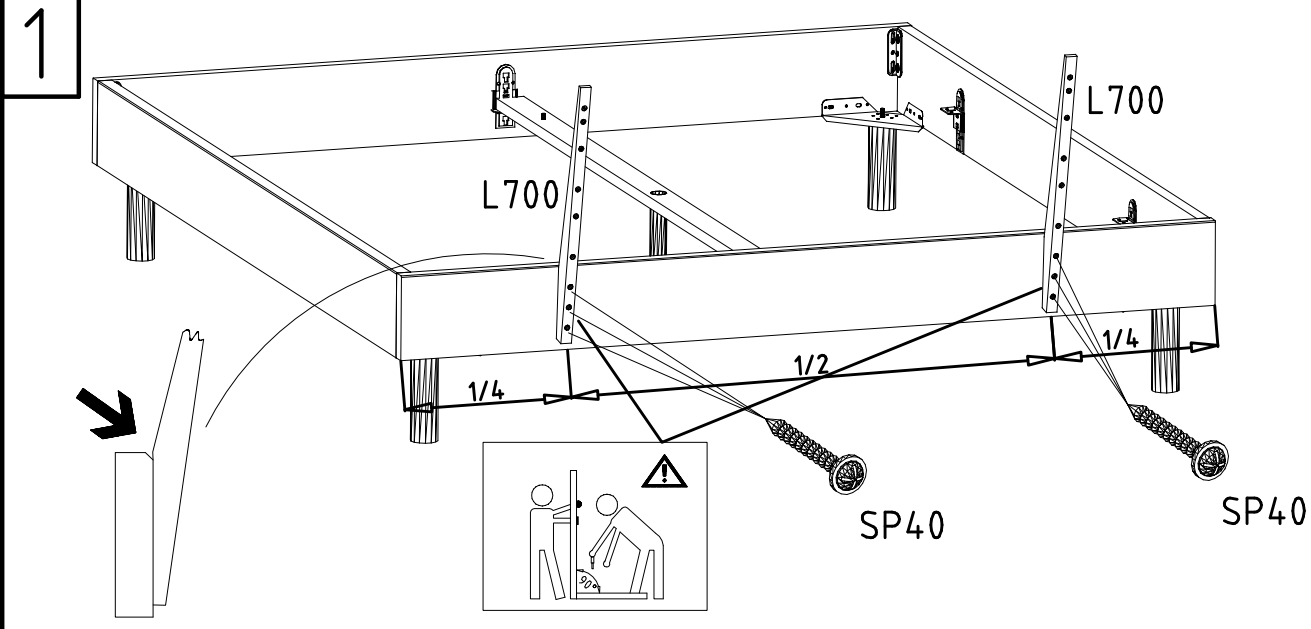

121 115

**SP40**

4 X 40 mm

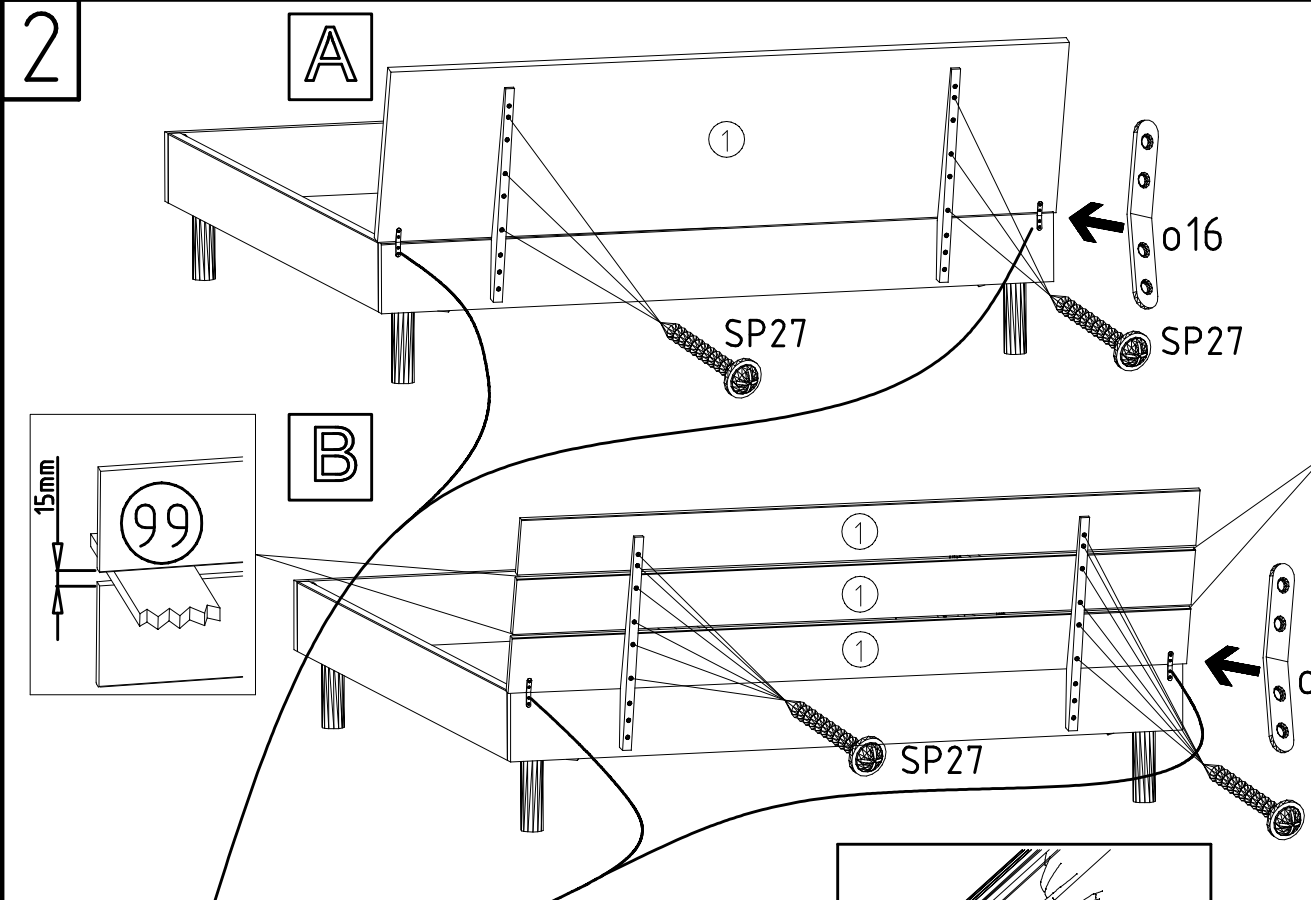

**SP27**

4 X 27mm

122620

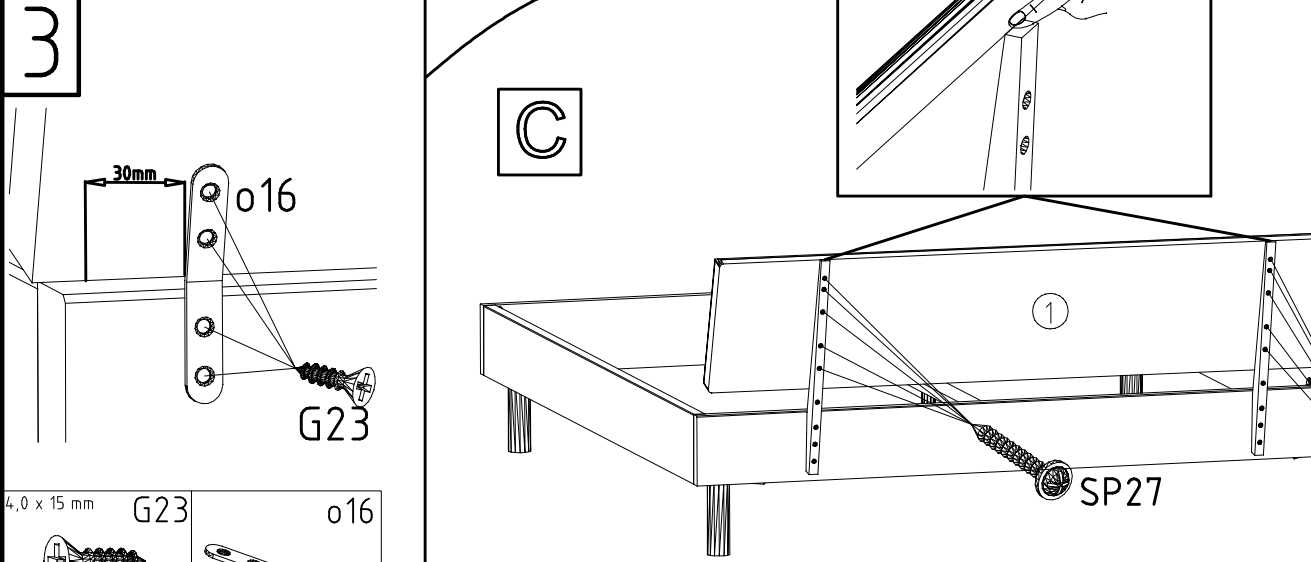

4,0 x 15 mm

**G23**

ø16

121 110

111 004